



SWTEST

PROBE TODAY, FOR TOMORROW

2024 CONFERENCE

Narrow Pitch Impedance Standard Substrates (ISS) for Pyramid Probe Applications



Dr. Pratik Ghate, Tomo Yokoyama

Objective

- The objective of this work is to understand and characterize the impact of narrow pitch on:
 - Signal integrity
 - Crosstalk
- Develop strategies to improve measurement capability to support shrinking pitch requirements.
- Define potential alterations to the design of standards to ensure continued accuracy in measurement.

Overview

- Market Drivers
- Benefits and Challenges with Narrow Pitch
- Design and Test Setup
- Results
- Future Work
- Key Takeaways

Market Drivers

Growth of Generative AI Driving Increased Speeds

- The growth of Generative AI has led to a rapid increase in demand for higher data rates and more efficient communication
- Examples include:
 - Text Generation – ChatGPT, Gemini
 - Video Generation – Sora by Open AI, Deepfake Technology
- These models have billions or even trillions of parameters
- To meet this need, data transfer speed, operating frequencies and bandwidths must increase



Image: Tony Baggett/Adobe Stock

High Data Rate Exceeding 200Gb/sec

- Factors driving increase in data rates:
 - Real time interaction
 - Increase in data processing
 - Data storage
- Data centers increasingly utilize optical communication systems for high-speed data transmission, low latency, high bandwidth, storage, etc.
- To enable high data rate IO devices (such as transimpedance amplifiers (TIA's), laser diodes etc.) will need to be tested at higher frequencies.

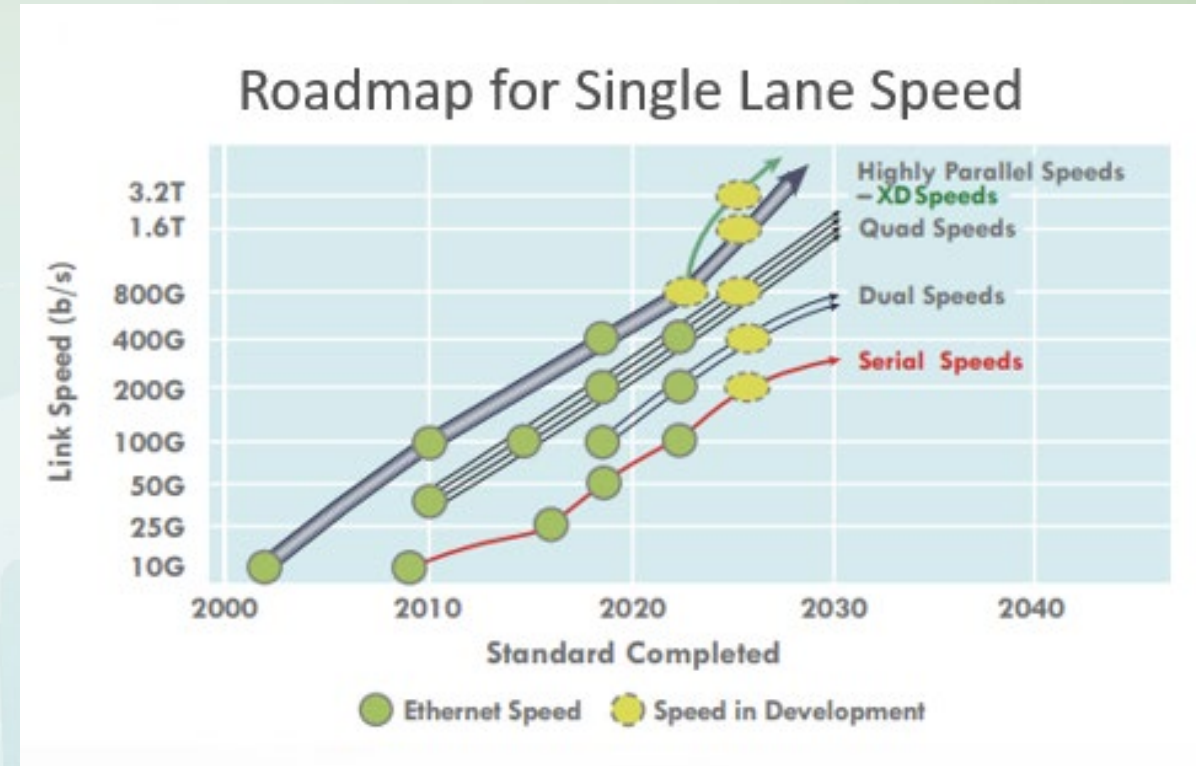

Mass Adoption of Differential Signaling

- As device circuitry becomes more compact and pitch correspondingly shrinks, crosstalk between signals increases which negatively impacts signal integrity.
- Most IO devices operate with differential signaling for the following reasons:
 - Improves noise rejection
 - Supports increased bandwidth
 - Reduces crosstalk
 - Provides an optimal signal return current path

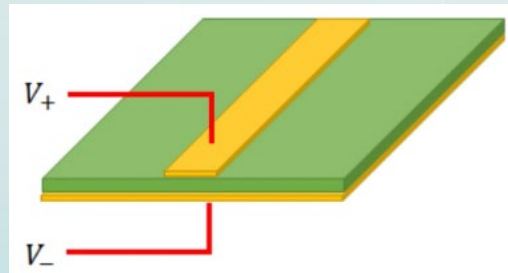

Single Ended Microstrip Transmission Line

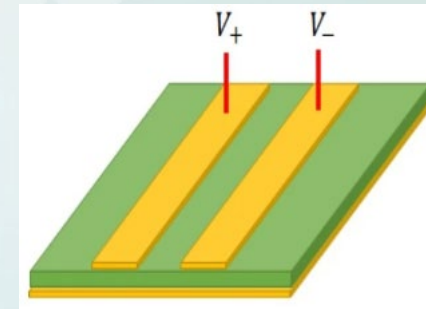

Differential Pair Microstrip Transmission Line

Benefits and Challenges of Narrow Pitches

Benefits

- Reduced EM parasitics because of smaller pad size

Challenges

- Increased crosstalk
- Impedance matching
- Increased capacitive losses
- More complex calibration
- More complex assembly and testing process
- Probing issues
- Higher manufacturing cost

This study focuses on crosstalk analysis for different calibration standards

Design and Test Setup

What is a Calibration Substrate?

- Calibration substrates contains a variety of precisely defined impedance standards and transmission lines, that are used to move the reference plane at the end of probe tip.

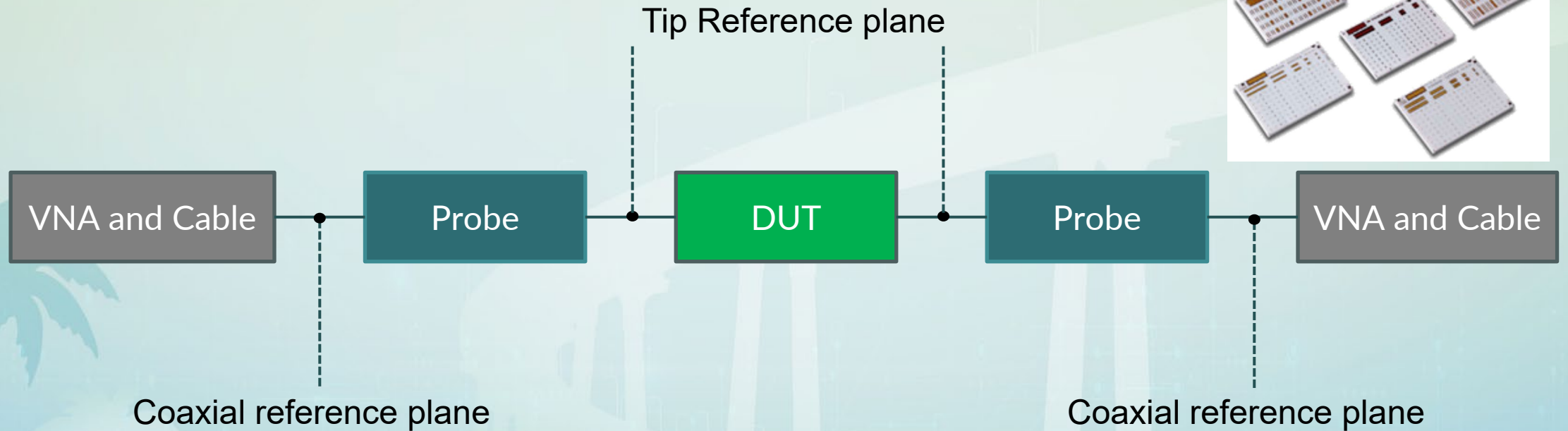

Comparison of Various RF Calibration Techniques in Production: Which is Right for You?
SWTest 2014 Presented by Daniel Bock

Calibration Substrate Design

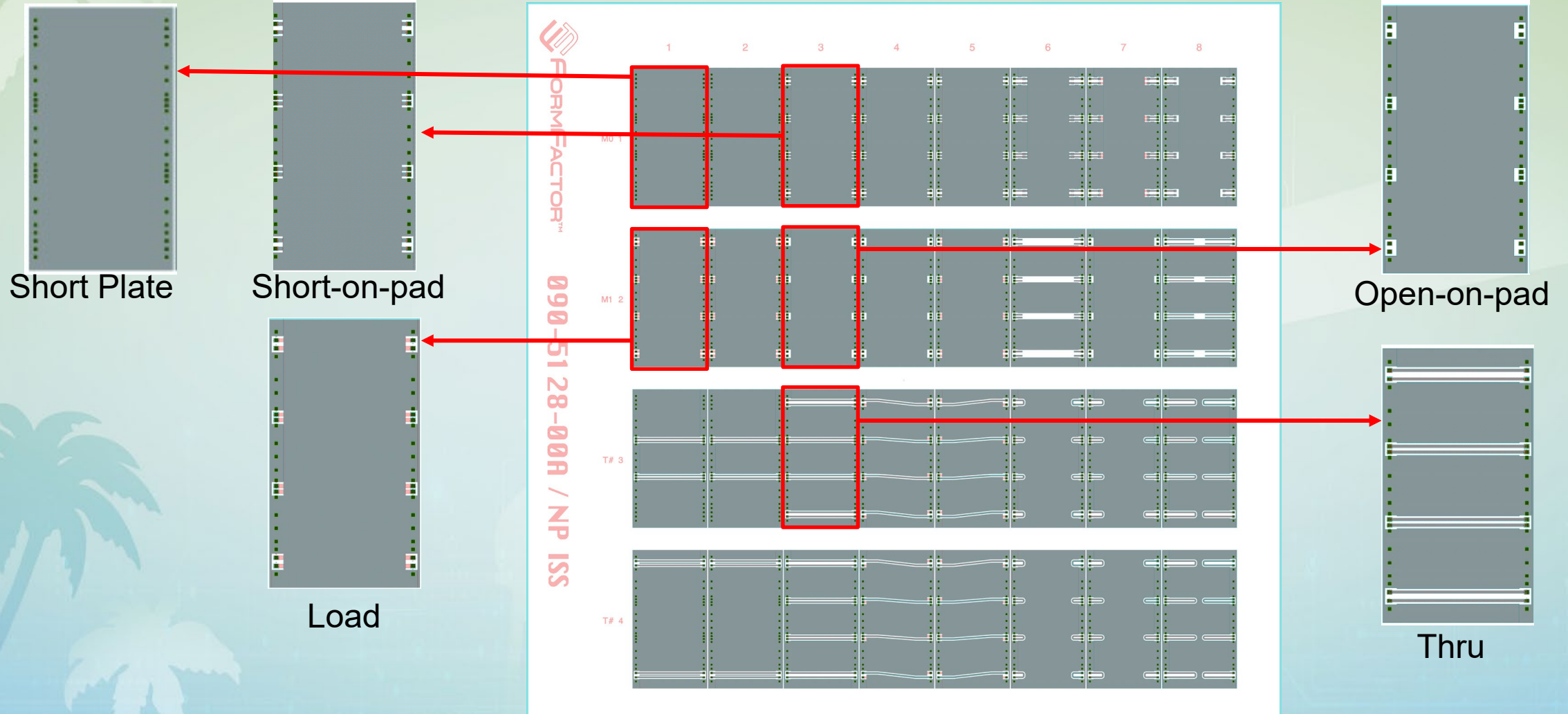

Pyramid Probehead Design

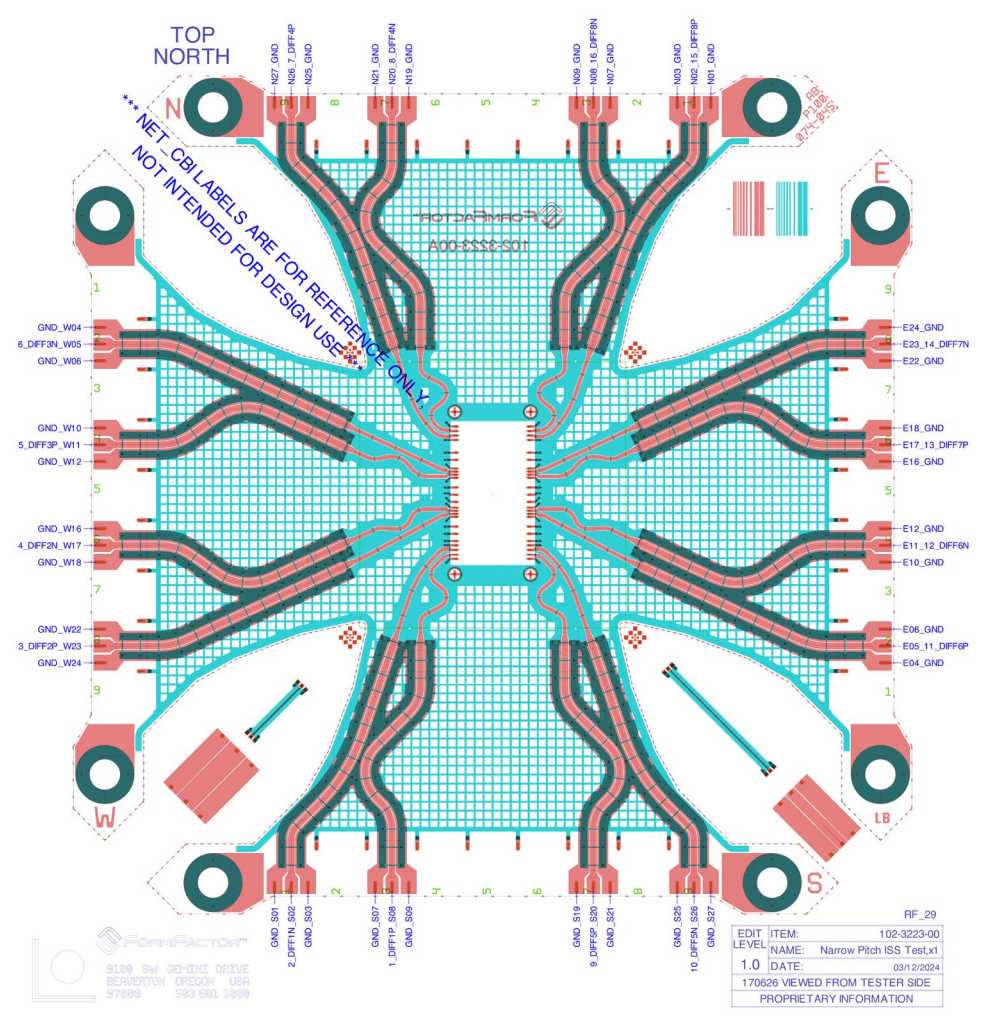

Membrane Design

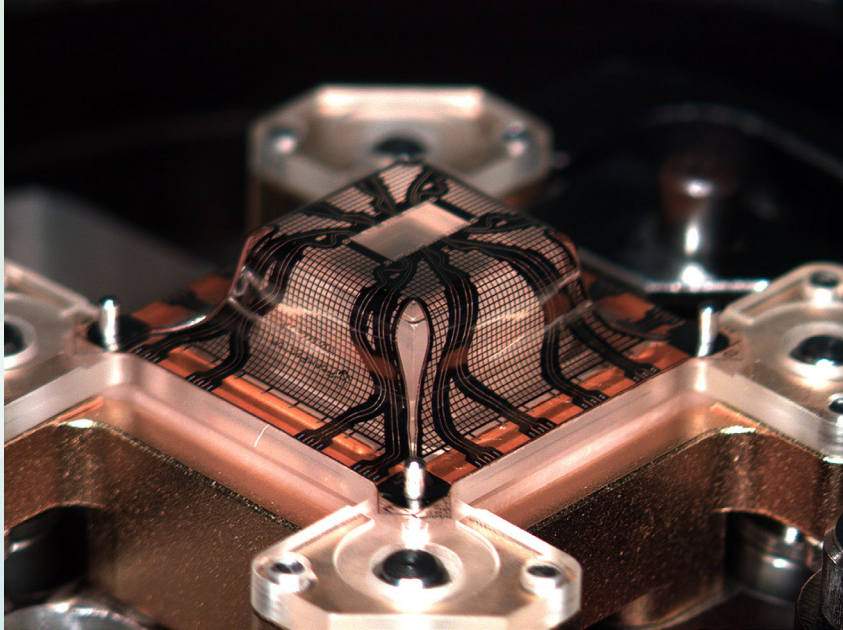

Prototype Pyramid core

Differences in Calibration Substrate Test Environments

- Calibration substrate was designed, and testing was done using
 - Analytical Probe
 - Pyramid Probe
- Results were compared for two test environments

Analytical Probe



Pyramid Probe

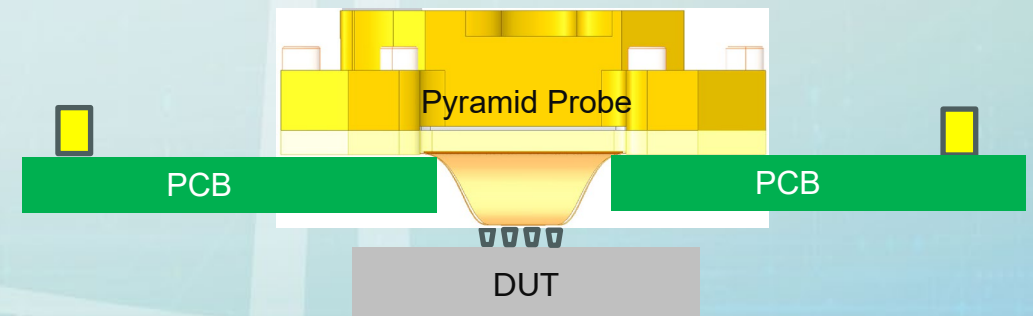

Experimental Setup

Analytical Probe Experiments

- FFI Summit 12000 semi-auto station
 - I67-D-GSSG-125
 - I67-D-GSSG-90

Pyramid Probecard Experiments

- Ebisu station (Customized Summit 12K)

Common Equipment

- Keysight PNA with 4-port capability
 - 50 MHz - 67 GHz
 - 50 MHz steps
- Keysight Electronic Calibration Module



Experimental Pyramid Probe in Test Environment



Analytical Probe in FFI Summit 12K

Results

Tighter Pitch Leads to Significant Crosstalk on Loads

- Simulation results matches very closely with the measured data.
- Significant crosstalk between adjacent tips in G-S-S-G probe, regardless of probe types and pitches.

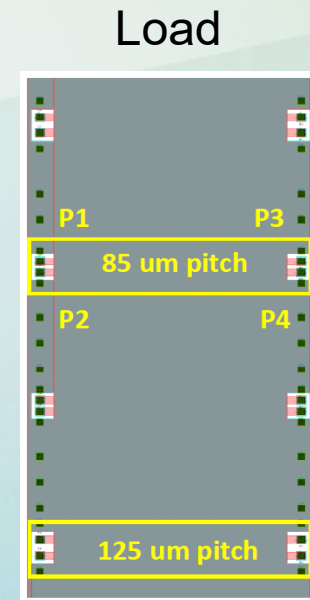
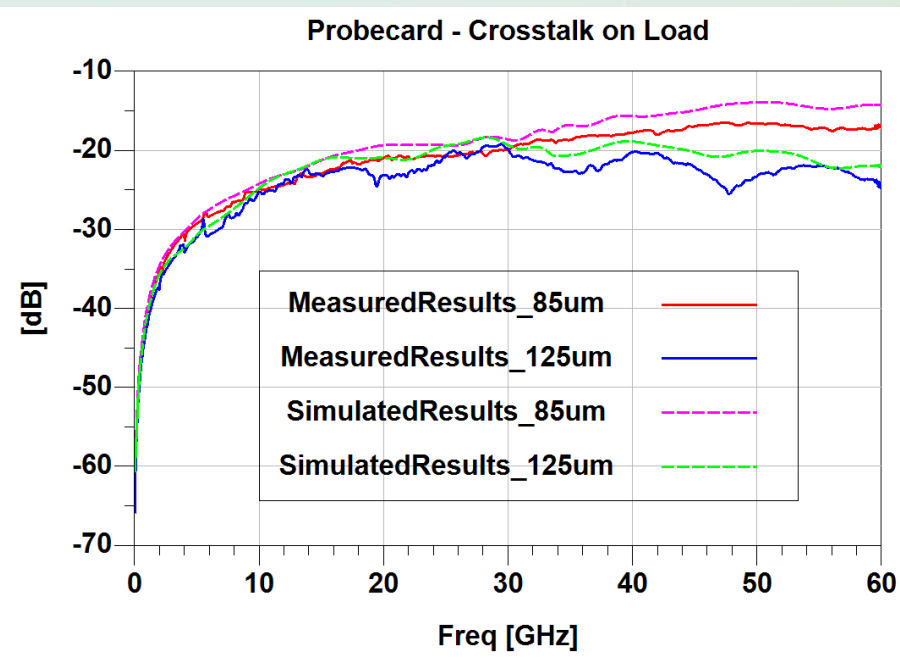
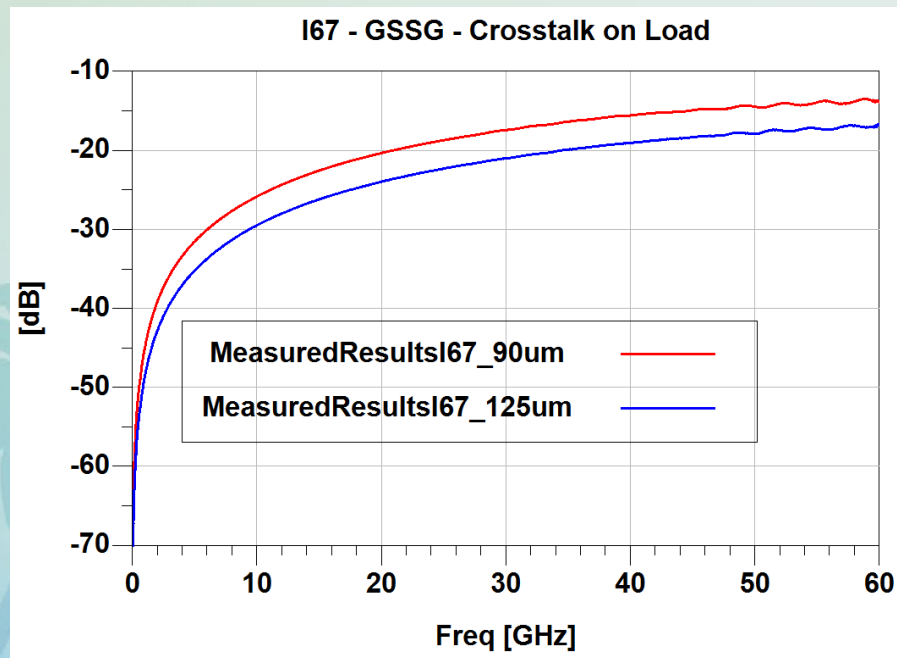

Open-on-Pad Minimizes Resonances

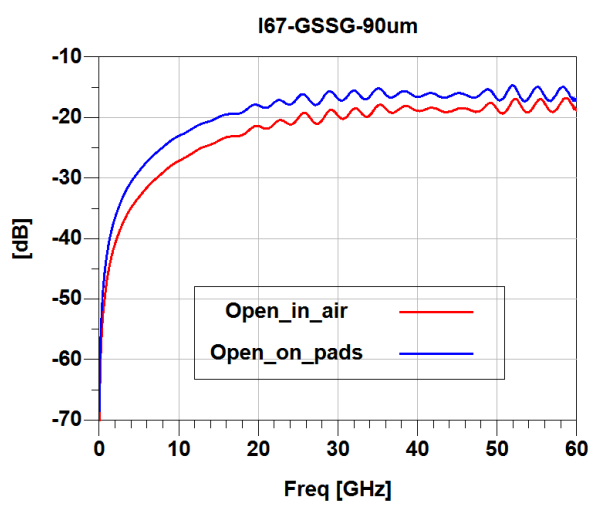
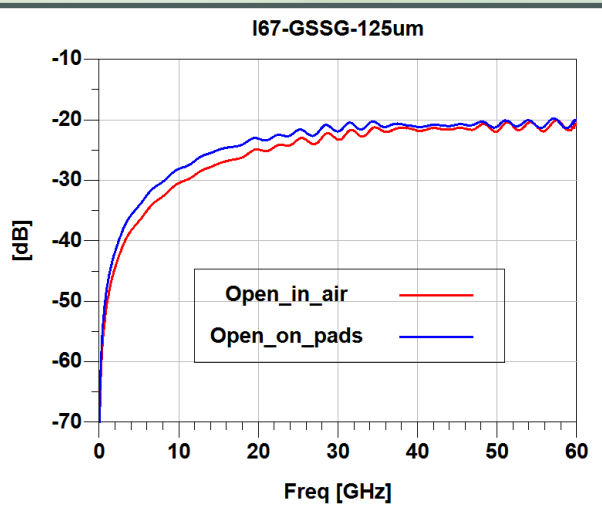

Analytical Probe

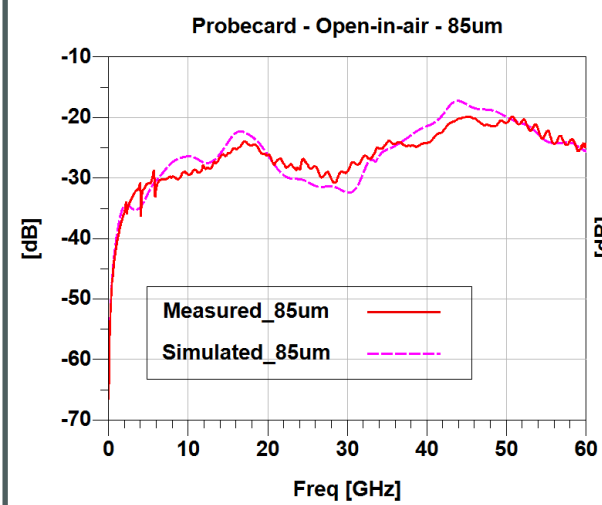
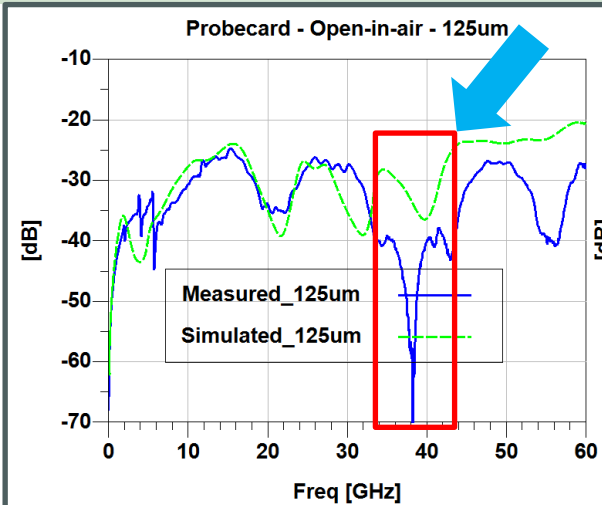

Pyramid Probe

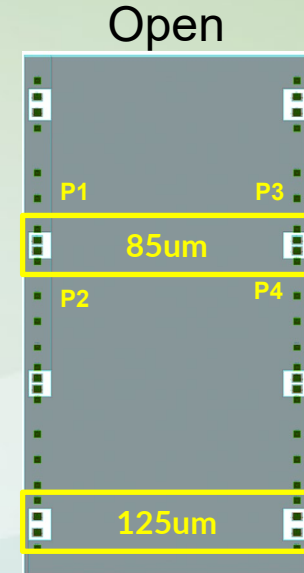
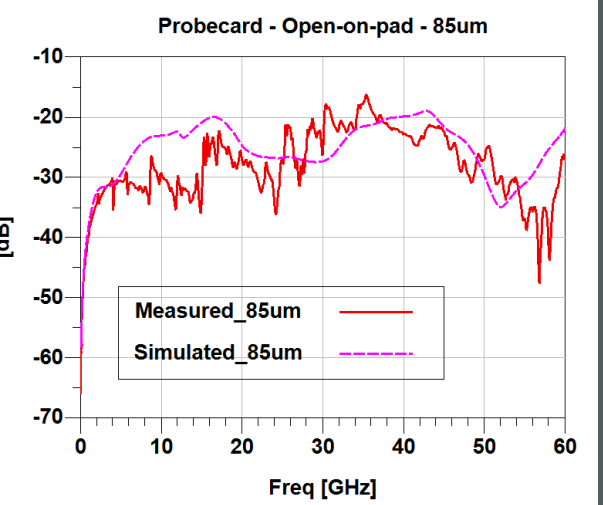
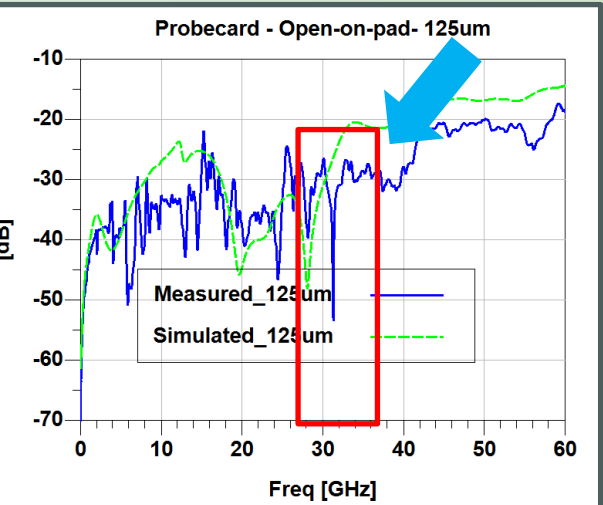

- Prefer using open-on-pad:
 - Open-on-pad minimizes resonances
 - Maintains consistency with other standards

Crosstalk Analysis for Short

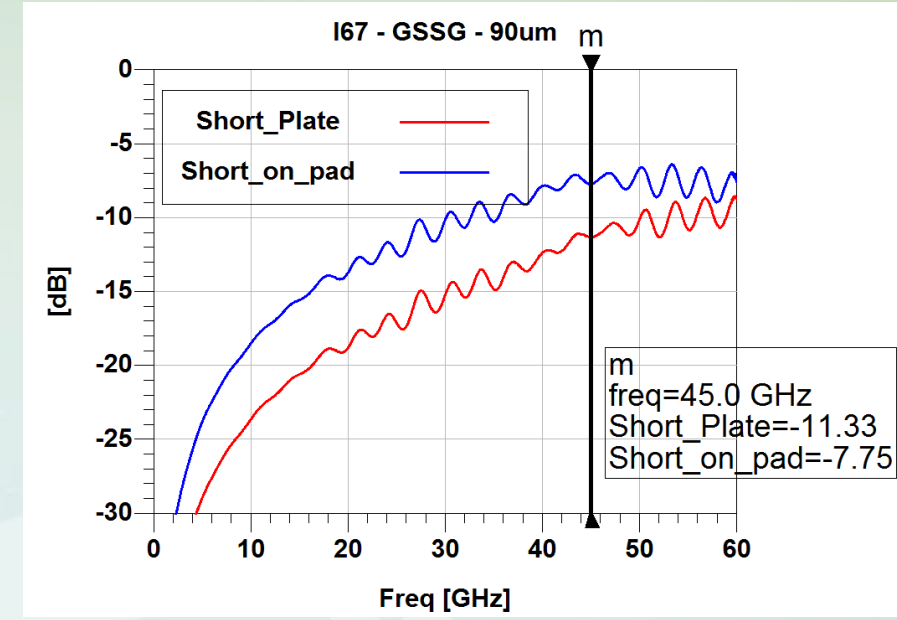
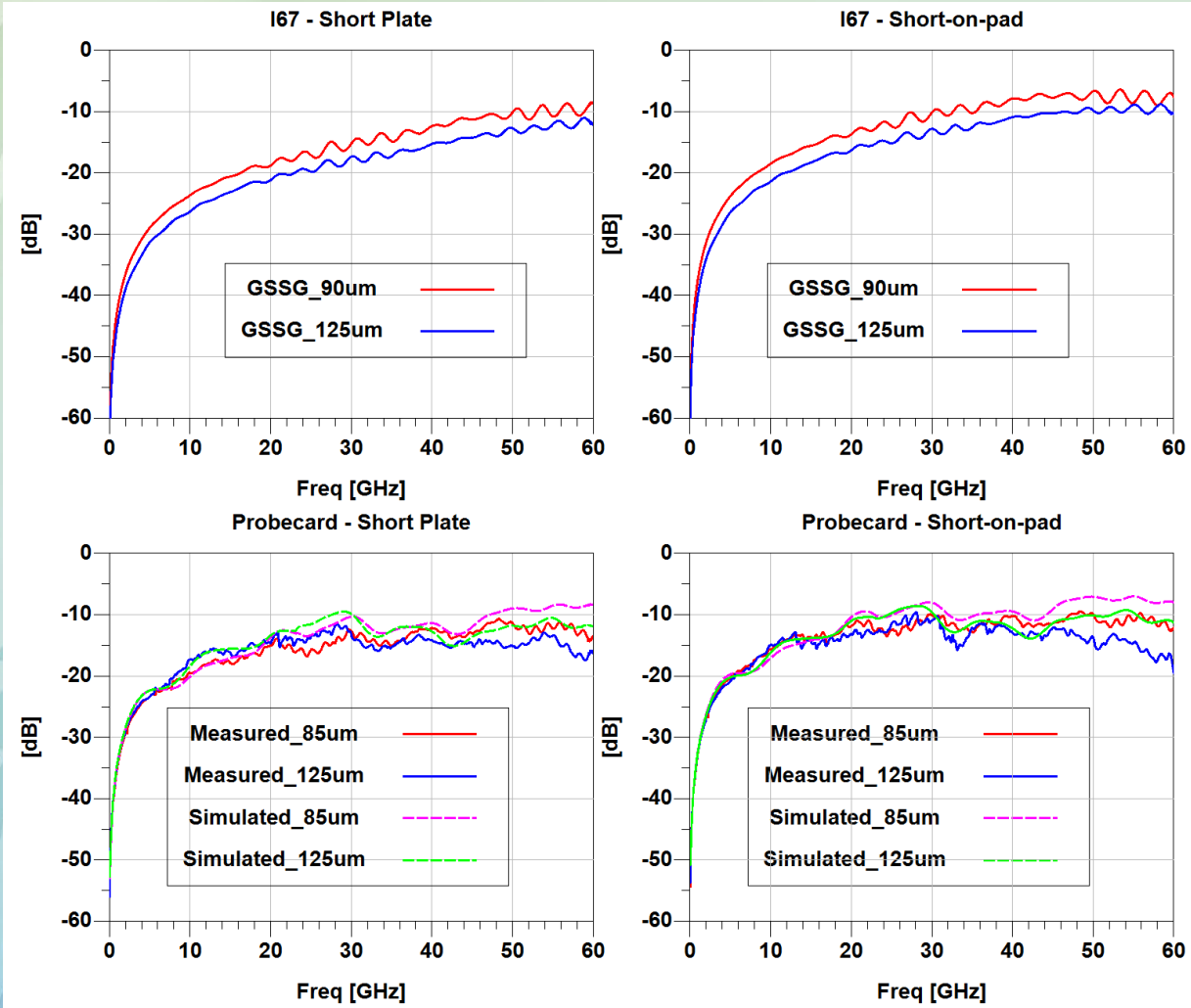

- Short-on-pad provides improved capability to capture crosstalk of DUT
 - Use of 'short plate' underestimates the crosstalk, resulting in inaccurate DUT measurements.

No Crosstalk Correction Causes Gain on Thru (125 um pitch)

Effect of Xtalk Correction on THRU (ISS 090-0528): I67-GSSG-125um probes

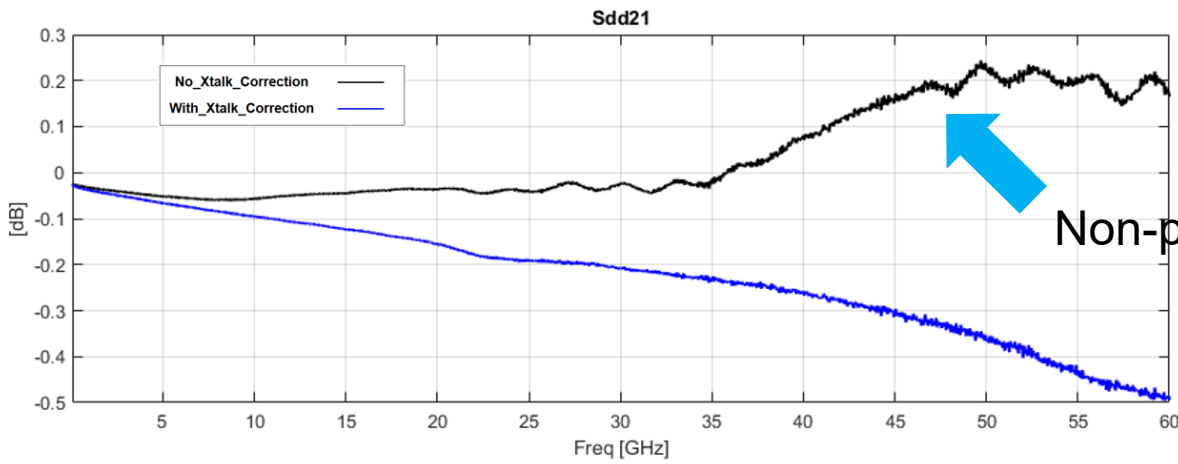
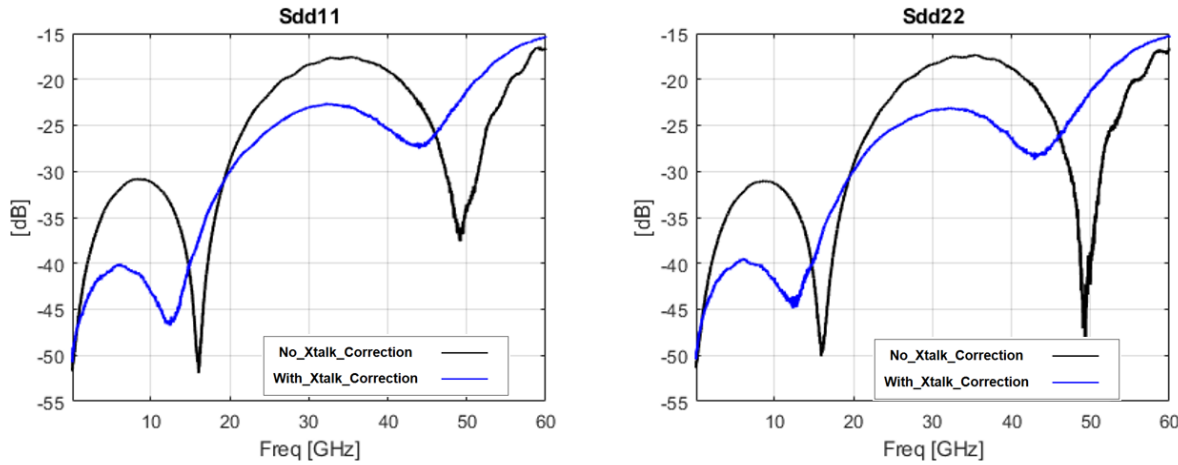

- A standard VNA 4-port calibration results in non-physical gain behaviors in Sdd21 insertion loss.
- Important to consider crosstalk calibration for higher frequency measurements with GSSG probes.
- Used proprietary modal calibration algorithm to account for crosstalk effects.

Thru

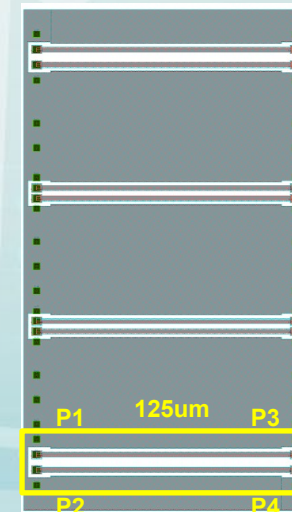

No Crosstalk Correction Causes Gain on Thru (85 um pitch)

Effect of Xtalk Correction on THRU (ISS 090-0528): I67-GSSG-90um probes

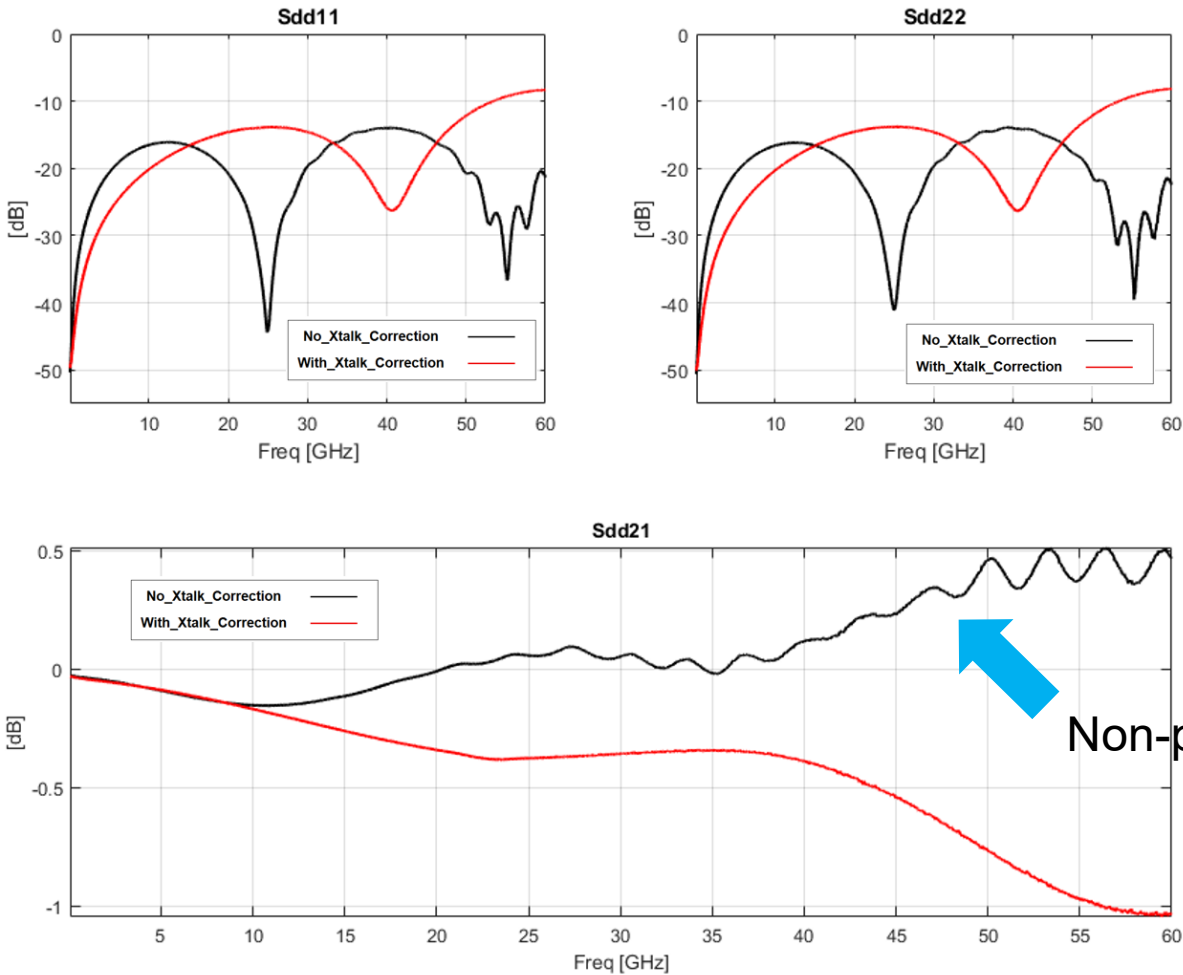

- Used 90 um pitch probes (I67-D-GSSG-90).
- Significant crosstalk for 85um pitch Thru.
- High mode conversion leading to difficulty in calibration.

Thru

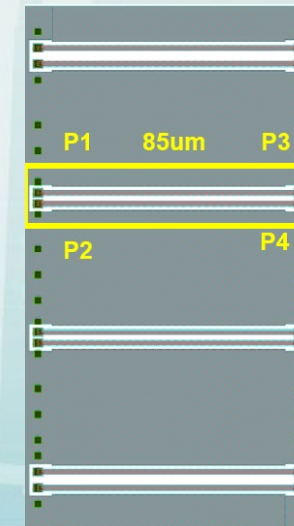

What's Next?

Future Work

Pyramid Probe:

- Pyramid probe show a greater sensitivity to the geometry of probe-DUT interface than analytical probes. A key next step is to understand how measurements differ at different locations on the same calibration substrate.
- Investigate the inverted microstrip traces near the DUT to achieve better isolation from the DUT. We have observed using CPW near the DUT increases coupling.
- Study various test environment effects, and how these impact p-probe measurements.

Analytical Probe:

- Study the calibration standards with 85um pitch

Key Takeaways

- Narrow pitch and smaller pads facilitate tighter control of EM parasitic effects.
- Narrow pitch calibration substrates require different design considerations than standard pitch substrates
 - Example: Coupling from adjacent DUT is more pronounced
- Physical location of standards on calibration substrates plays a significant role in crosstalk between calibration substrate and the probehead.
- To deliver consistent parasitic effects to mimic DUT launch/pad, use short-on-pad over short plate and open-on-pad over open-in-air.
- Narrower pitch probecard design is challenging due to greater sensitivity to test environment factors.

Questions

