

Cascade

# Autonomous Silicon Photonics Measurement Assistant



Proven Technology and Verified Measurements  
Make a Difference



## Making Photonic Measurements: More Than Positioners on a Probe Station

FormFactor understands a test engineer's goal is to make measurements. An integrated, verified solution will prevent engineers from spending valuable time on long development projects.

*"FormFactor's SiPh Measurement Assistant enables faster time to more accurate measurements and reduced cost of test."*

We have developed all the tools, fixtures and calibration techniques to enable you to measure your photonic devices in days instead of months or years.

FormFactor's Autonomous Silicon Photonics Measurement Assistant is a highly flexible solution that enables quick changeover for a multitude of testing needs from **single fibers to arrays** and from **vertical coupling to edge coupling**.

Our Photonics Integration Kit and the revolutionary OptoVue Calibration Kit, will get you production-proven, optimized optical measurements right after installation.

## Industry-First Features

**Validated** Integration,  
**Verified** Performance

Wafer and Die-Level  
**Edge Coupling**

**Integrated**  
Z-Displacement

In-Situ Calibrations and  
Singulated Die Testing  
with **OptoVue Pro**

**Automated** Optical  
Positioning Calibrations  
and Alignments

**Highly Flexible Solution**  
for Single Fibers/Arrays  
and Edge/Vertical Coupling

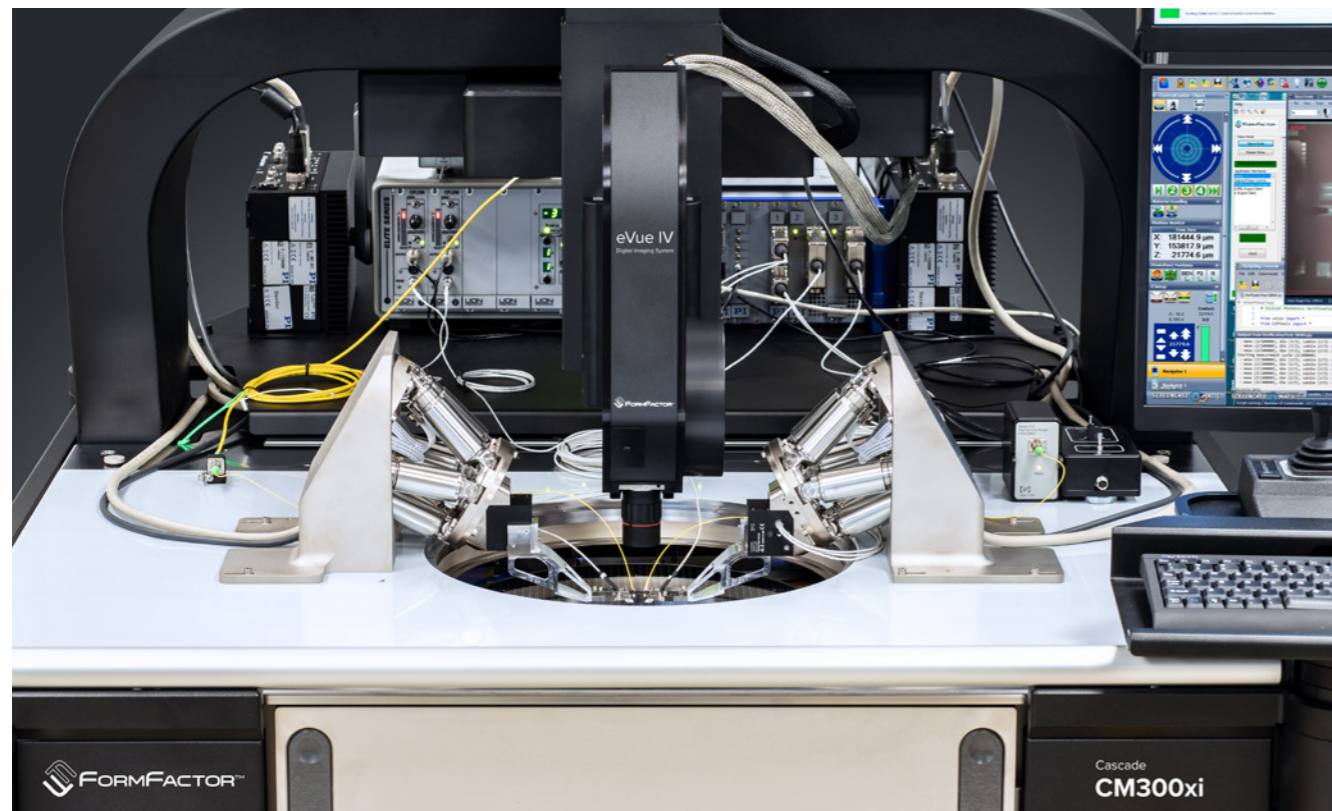

FormFactor's CM300xi Probe Station: Highly-stable and robust 300 mm platform for optical probing

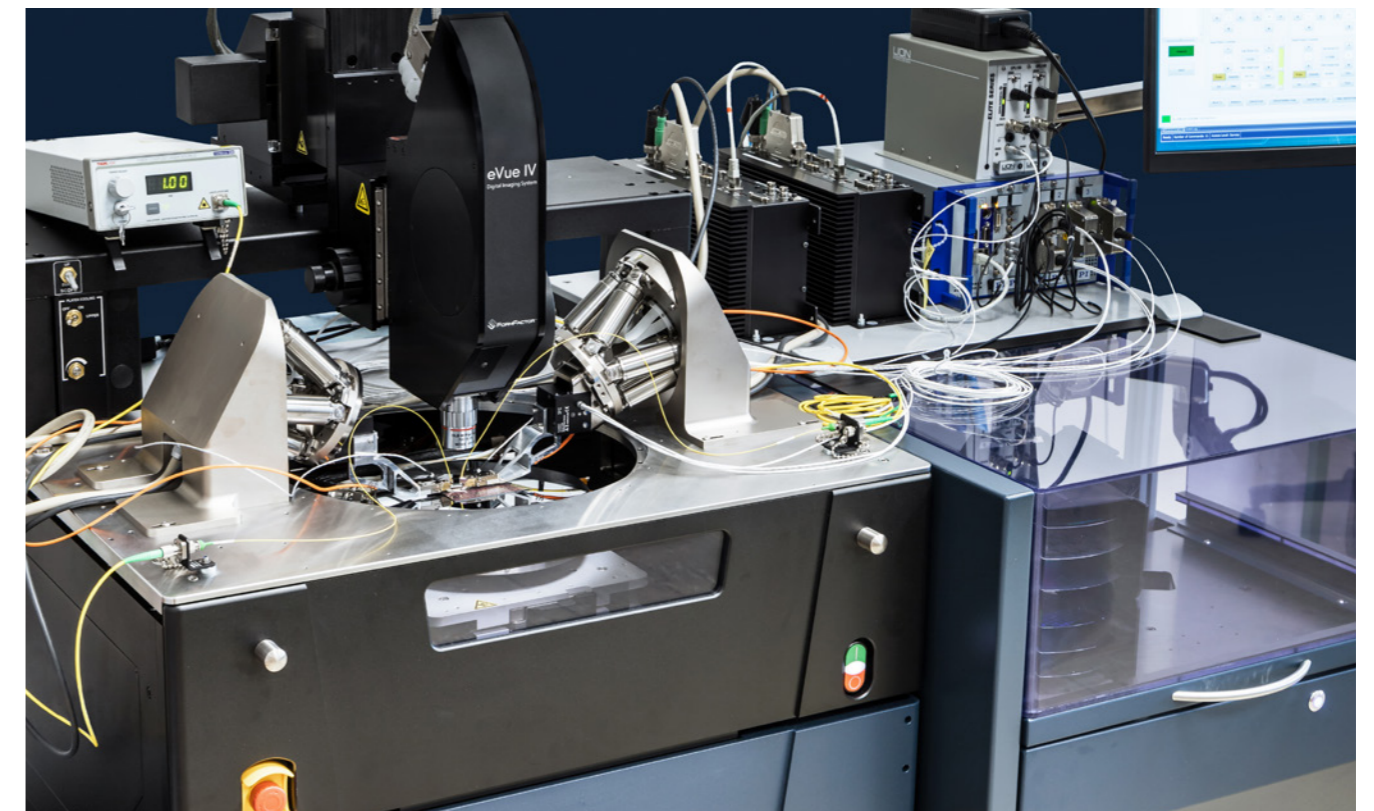

Silicon Photonics Measurement Assistant on FormFactor's 200 mm probe station SUMMIT200

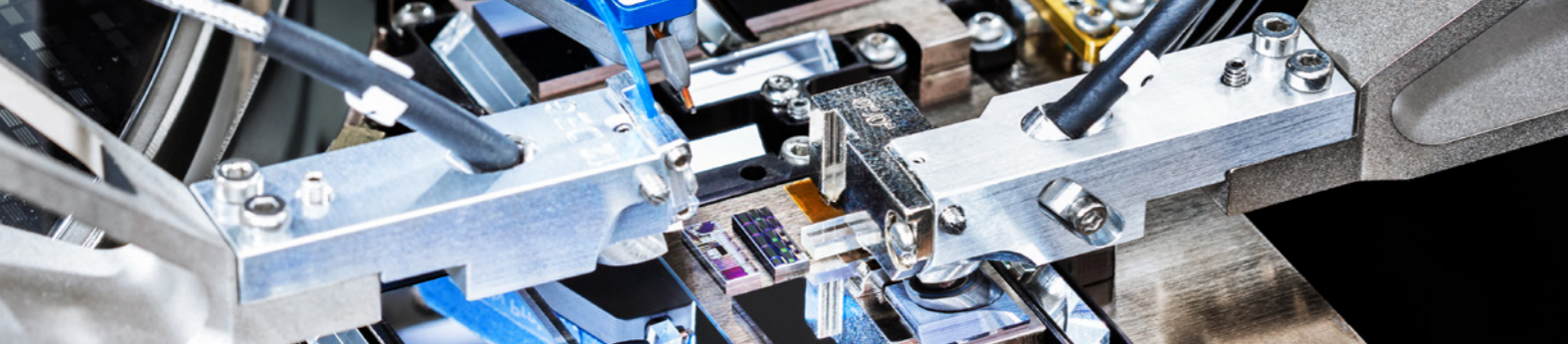

## OptoVue / OptoVue Pro

### Faster Time to Data with Real-Time In-Situ Calibration



#### Features

Real-Time In-Situ Calibrations

True Die-Level Edge Coupling

Advanced Calibration Technologies

Singulated Die Testing

In-Situ Power Measurements

Enables Autonomous Measurements



FormFactor brings a revolutionary technology advancement for wafer and die-level photonics probing with its OptoVue and OptoVue Pro. This feature includes advanced calibration technologies with more viewing directions and significant additional features that enable faster time to more accurate measurement results.

Situated in auxiliary chuck locations on the CM300xi and SUMMIT200, OptoVue and OptoVue Pro enable calibrations to be performed in-situ without removing

the test wafer to put a calibration wafer on the chuck. This CalVue feature enables seamless calibrations without operator interaction, resulting in faster time to measurement and reduced cost of test.

OptoVue Pro includes a feature-rich set of tools for optical probing including DieVue for die-level probing of singulated photonic devices, ProbeVue for inspecting and measuring fibers and fiber arrays, and PowerVue for measuring laser power at the probe tip.

#### CalVue

- / In-situ calibration for Z-Displacement and optical positioning

#### PowerVue

- / High sensitivity photodiode
- / Power Measurements up to 40 mW
- / Enables in-situ power measurements at the measurement plane of single fiber and fiber array
- / Measure and remove laser to fiber tip path loss

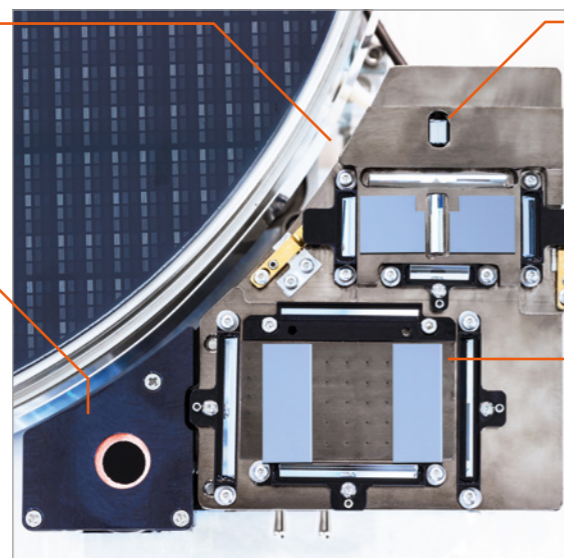

(Image shows OptoVue Pro on a CM300xi.)

#### ProbeVue

- / Upward looking probe inspection function for single fibers, fiber arrays, DC and RF probes
- / Find initial array coupling offset position from corner

#### DieVue

- / Singulated die test
- / Up to 25 x 25 mm die
- / Vacuum secured
- / Customizable die holder
- / Vertical and edge coupling

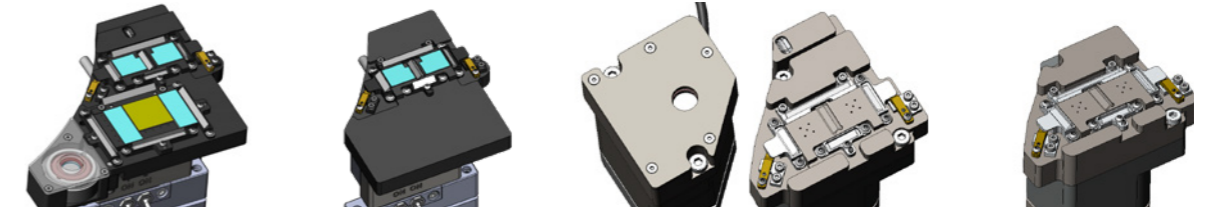

Feature	OptoVue Pro	OptoVue	OptoVue200 Pro	OptoVue200
CalVue	✓	✓	✓ (replaceable with DieVue)	✓
PowerVue	✓	-	✓ (placed on front left, flexible location in case of upward looking camera)	-
ProbeVue	✓	-	✓	-
DieVue	✓	-	✓ (replaceable with CalVue)	-



Probe inspection with ProbeVue



In-situ power measurements with PowerVue



Pull-out chuck with OptoVue Pro in the auxiliary chuck position - CM300xi

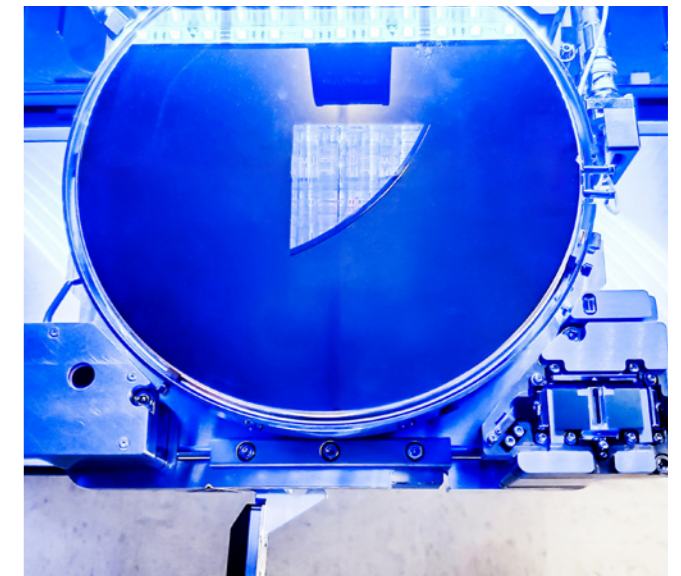

Pull-out chuck with OptoVue Pro 200 in the auxiliary chuck positions - SUMMIT200

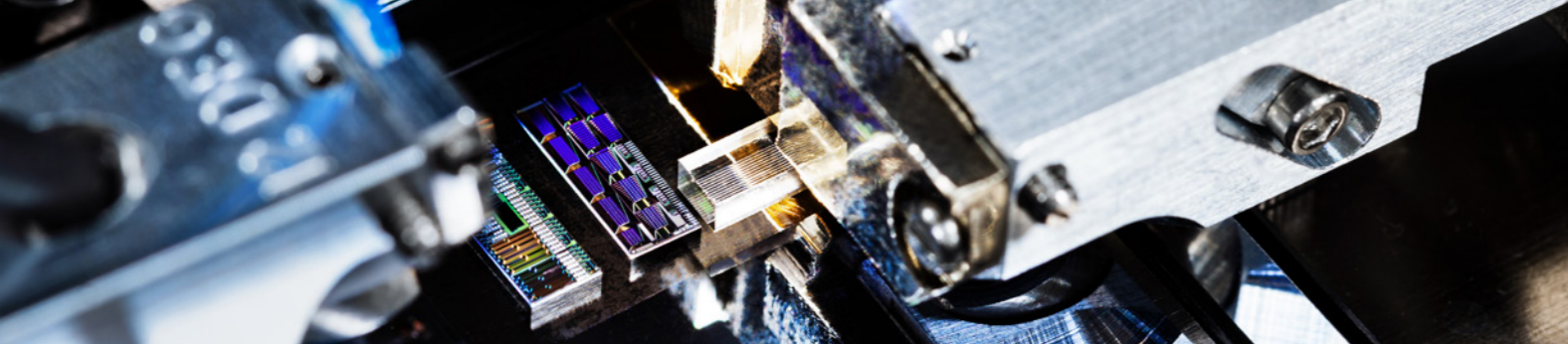

## Edge Coupling

High Coupling Efficiency for High Bandwidth

### Features

Highest Accuracy in Test Results

Automated Fiber-to-Facet Alignment

Optimization of Gap Between Fiber Tip and Waveguide

Lowest Coupling Loss

Fiber Collision Avoidance

Ease of Use for Less Experienced Users



### Horizontal Die-Level Edge Coupling

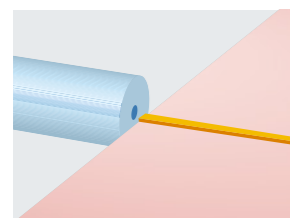

The best coupling efficiency for high bandwidth applications is achieved by getting fibers/arrays as close as possible to the exposed waveguide facet(s) through horizontal die-level edge coupling.

True edge coupling enables close simulation of real-world conditions with device performance closest to the final application.

FormFactor provides the only solution on the market that enables advanced automated alignment for horizontal die-level edge coupling, deploying exclusive automated fiber-to-facet alignment techniques and reducing the risk of damaging fibers to a minimum with collision avoidance technology.

Unique software algorithms like AlignOpticalProbes3D enable optimizing the fiber-to-facet gap versus maximum coupled power at both the input and output simultaneously.

No other solution available enables you to get the positioning hardware calibrated in the YZ plane and ready to perform edge coupled optical optimizations.

### Wafer-Level Edge Coupling

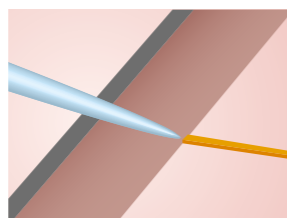

Wafer-level edge coupling is now possible with a new innovative combination of hardware and software features to align and optimize fibers/arrays in a wafer-level trench.

A suite of software alignment algorithms enable YZ optimization scans in a wafer trench while tapered lensed fiber holders provide a low approach angle relative to the wafer surface. This enables alignment of the probe in the trench as close as possible to the facets, minimizing coupling losses with minimal trench dimensions.

The solution means easy setup even for less experienced users, repeatable measurement results due to unique fiber-to-facet gap alignment technology, and reduced risk of damaging fibers with collision avoidance technology.

## Industry-Leading Edge Alignment Features

### Measure3DCoupling

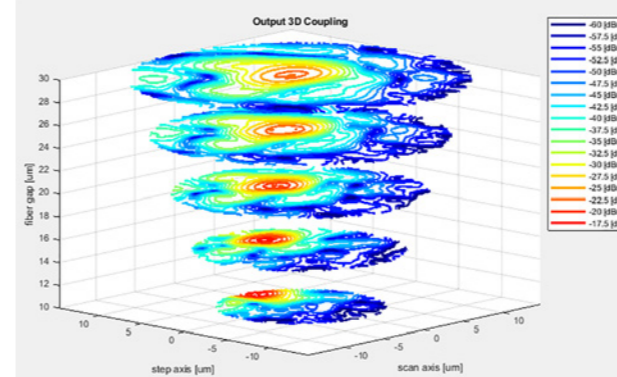

**Measure3DCoupling** performs successive area scans and stepping moves along the coupling axis, constructing a 3D image of power coupling. Useful for multiple purposes such as detecting fiber damage, detecting DUT contamination, measuring the focal length of lensed fiber, etc. Applicable to both edge and vertical coupling.

### AlignOpticalProbes3D

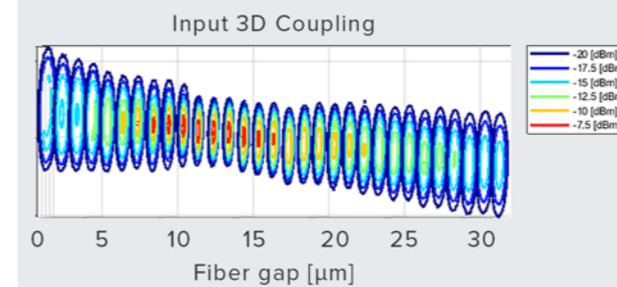

**AlignOpticalProbes3D** searches for the optimum gap for both input and output fibers that results in the maximum coupled power.

### AlignOpticalProbesEdge

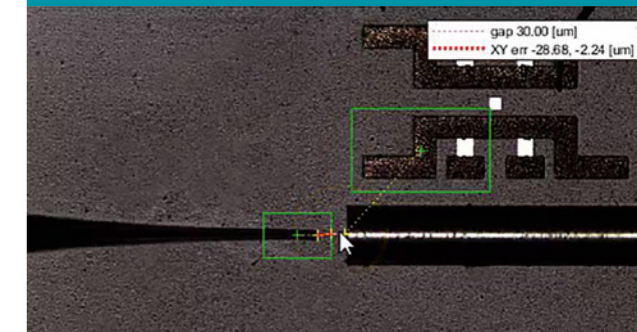

**AlignOpticalProbesEdge** executes a vision-based gap alignment on multiple selected probes and then performs YZ area scans while recentering as necessary.

### AlignOpticalProbeGap

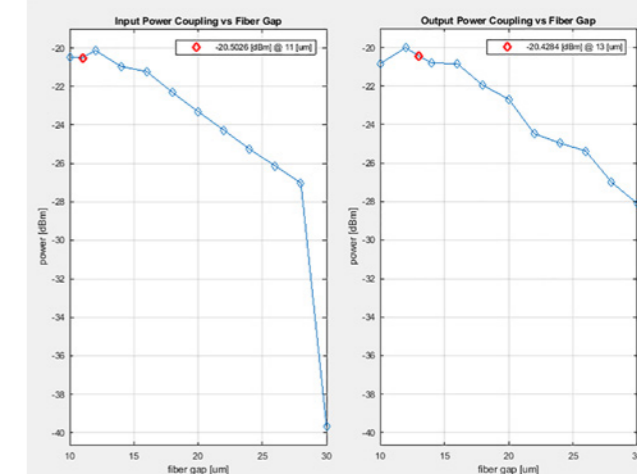

**AlignOpticalProbeGap** executes a vision-based gap alignment on a single probe in XY, moves to probe height in Z and readies for an area scan.



## Vertical Coupling Wafer-Level Coupling to Surface Gratings

### Integrated Alignment Features

Search First Light

Optical Rotation Scan

Optical Tracking

Incident Angle Calibration

Optical Scan Data Analysis

Align Optical Probes

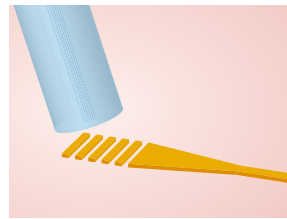

FormFactor's technology has become the industry standard for vertical coupling to wafer-level grating couplers. No other solution available gets the positioning hardware calibrated to the probe

station and ready to perform die-to-die optical

optimizations in minutes. With exclusive calibrations like Pivot Point, the optimal point of minimal translation at the fiber/array tip is automatically determined. Using this Pivot Point, FormFactor's Incident Angle Optimization routine enables you to determine best position to maximize coupling efficiency. Knowing how the optimized incident angle compares to designed incident angle can lead to discovery of fab or other process defects.

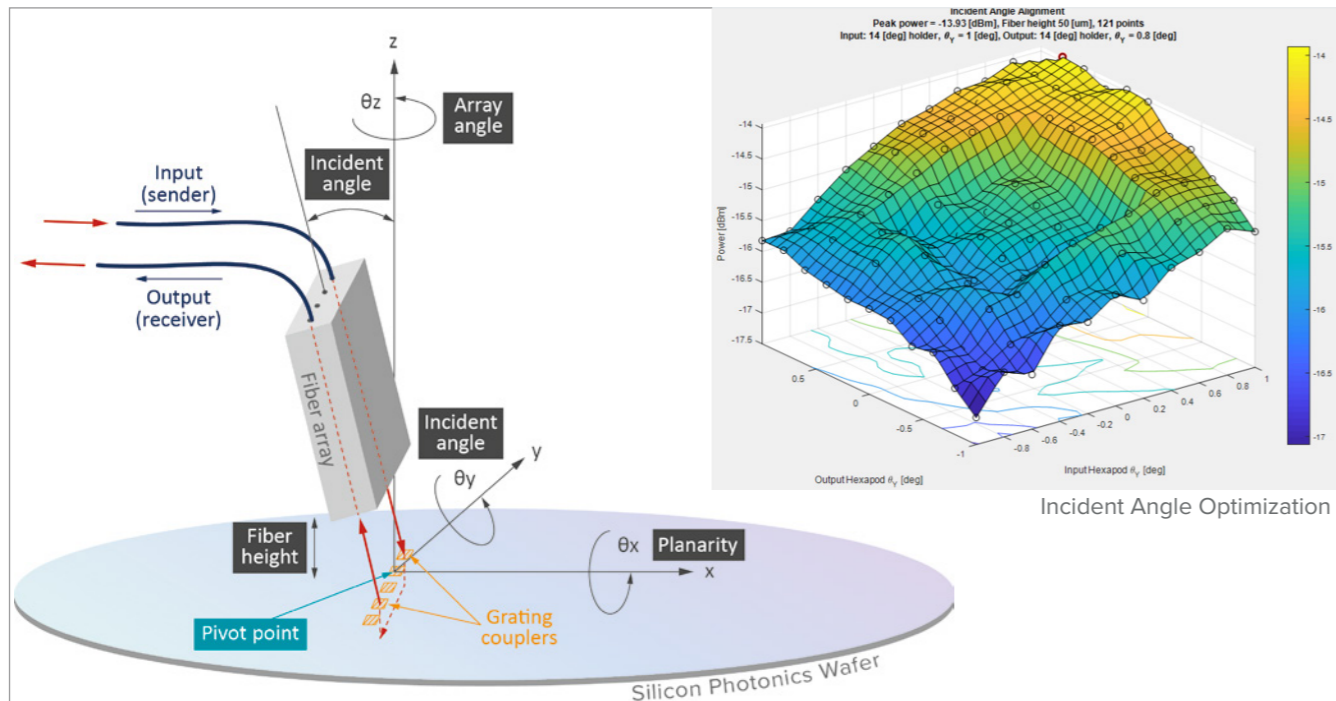

Incident Angle Optimization

## Thermal Capability Enables Autonomous Calibrations at Multiple Temperatures



### Features

Dark, Shielded and Frost-Free

-40°C to +125°C

Autonomous Calibrations at Multiple Temperatures

Unique Window for Easy Setup

Minimized Air Flow Impact on Fibers/Arrays

Reliable and Accurate Measurements



Performing measurements of optical devices at multiple temperatures is essential when it is necessary to conform to certain industry compliance standards. Whether it is devices for data centers that need to be tested in high temperature environments or automotive devices that require both hot and cold testing. The challenges that come with testing at multiple temperatures are system drift, air flow impact on the highly sensitive fibers/fiber arrays and the need for re-calibration.

FormFactor's unique SiPh TopHat is the only solution that provides a completely sealed, dark, shielded and frost-free environment with full thermal capability from -40°C to +125°C. Only the SiPh TopHat enables minimized air flow impact at cold temperatures to

the fibers/fiber arrays for stable and repeatable measurement results.

In combination with the revolutionary OptoVue/ OptoVue Pro and intelligent machine vision algorithms, the system enables true hands-free autonomous calibration and re-calibration at multiple temperatures. Thermal calibration intervals are completely configurable as the impact of thermal drift on fibers varies over the desired temperature range.

The SiPh TopHat was designed to prevent stiction which impacts motorized positioner accuracy. Cable management is designed into the mounting plates for both fibers and positioner cables. An exclusive ITO-coated TopHat window allows easy setup of probes without having to open the thermal chamber.

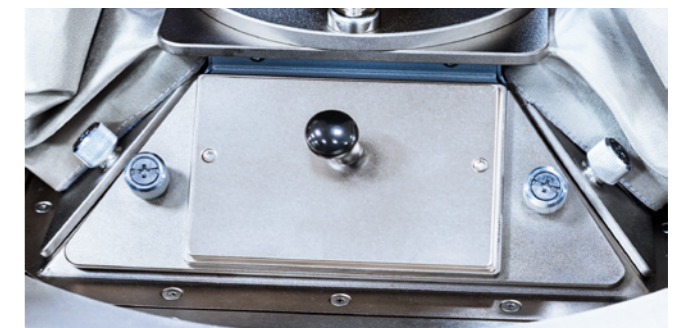
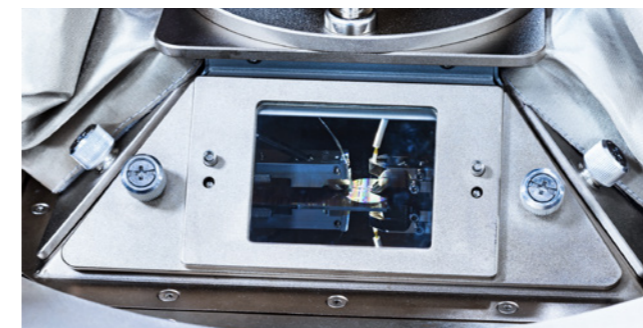

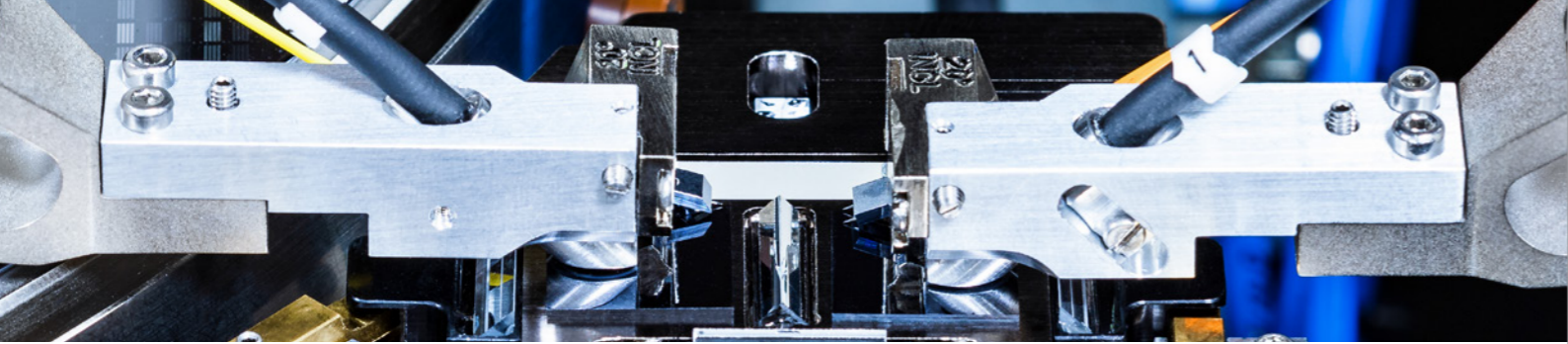

## CalVue Exclusive Automated Calibrations

### Calibration Functions\*

Motor Calibration

Theta Calibrations

Planarity Calibrations

Z-Displacement  
Calibration

PZT Calibration

Automatic Pivot Point  
Calibration



\*FormFactor's Autonomous SiPh Measurement Assistant is the only solution on the market that provides these features.

Get your system quickly in a state to perform the ultimate goal of making precise and reliable measurements on your devices.

FormFactor has developed a pioneering set of automated functions that perform critical calibrations of the optical positioning system to the probe station and step-by-step wafer to probe height training - even for combined optical and electrical probing.

With CalVue, part of OptoVue and OptoVue Pro, FormFactor moves these industry-exclusive automated calibration functions into the probe station. Utilizing uniquely designed retro-mirror technology, the objective lighting of eVue can be used to view all aspects of the fiber/array without external light.

This eliminates the need for oblique lighting and enables real-time in-situ automated machine vision calibrations.

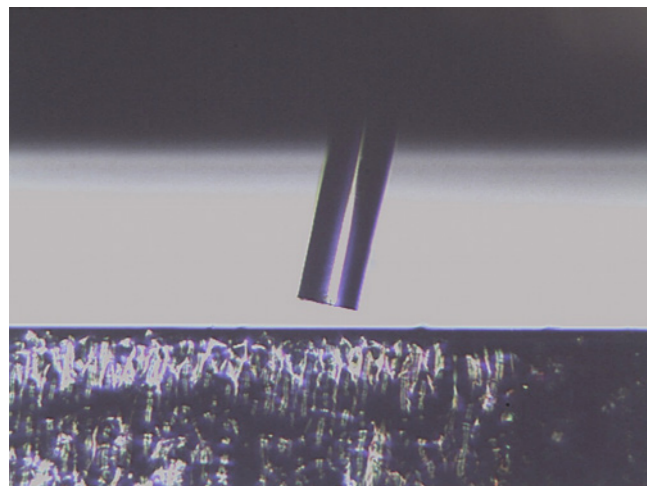

Horizontal view of single fiber with CalVue

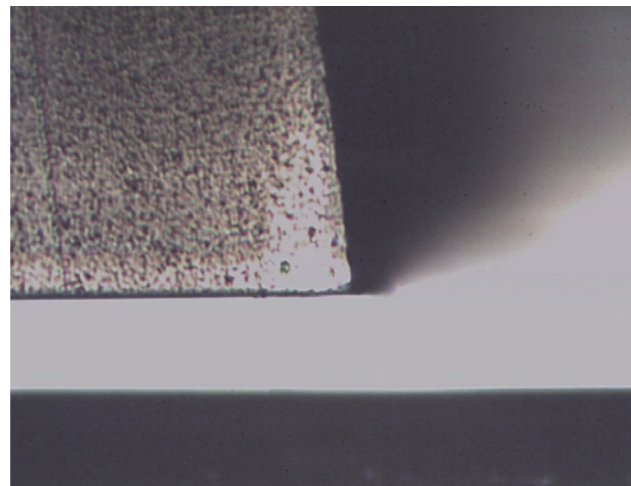

Horizontal view of fiber array with CalVue

## Proven Performance Automated Performance Verification

### Verified Parameters

Coupled Power Repeatability

Hexapod Motion Calibrations

PZT Motion Calibrations

Chuck Calibration to  
Optical Positioning



FormFactor has developed an automated test methodology that demonstrates the full performance of the positioning solution calibrated to the probe station with one click of a button.

The performance verification script ensures that all 9 or 18 Axis' of the positioning solution are accurately calibrated to the 4 Axis' of the probe station by measuring the coupled power repeatability of the whole system. A total of 900 measurements are made at 9 different waveguides in 3 reticles of FormFactor's Silicon Photonics Test Coupon wafer.

In between each of the 100 measurements performed at each waveguide, all solution elements are moved including the wafer chuck, hexapod stages and piezo stages. After all these motions, we verify that the system measures the coupled power results at each waveguide to within less than 0.3 dB across these 100 measurements.

This type of measurement performance truly demonstrates the integrated performance and robustness of FormFactor's Autonomous Silicon Photonics Measurement Assistant.

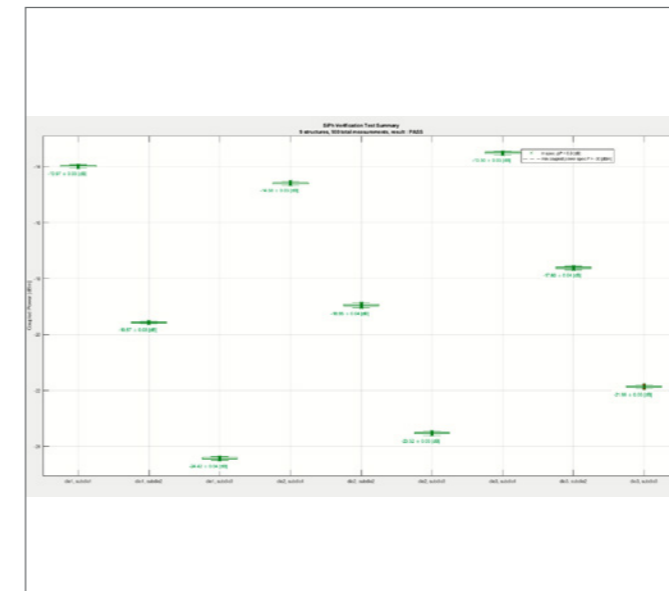

<0.3dB coupled power repeatability results

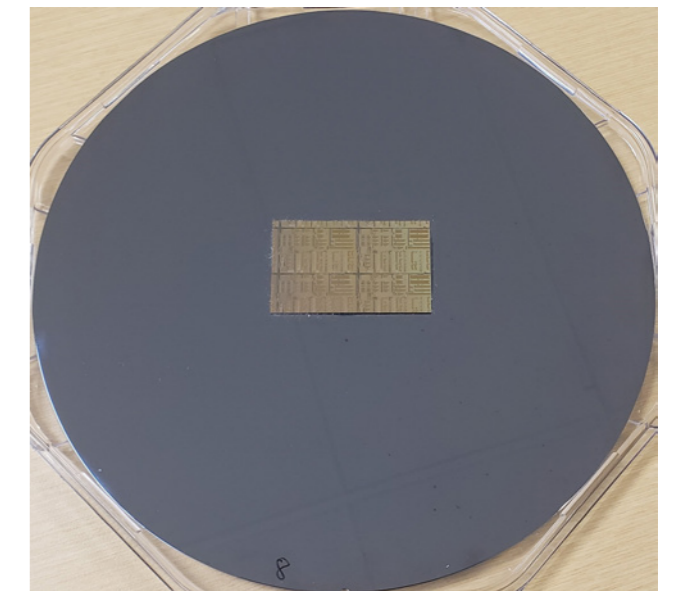

FormFactor Silicon Photonics test coupon wafer

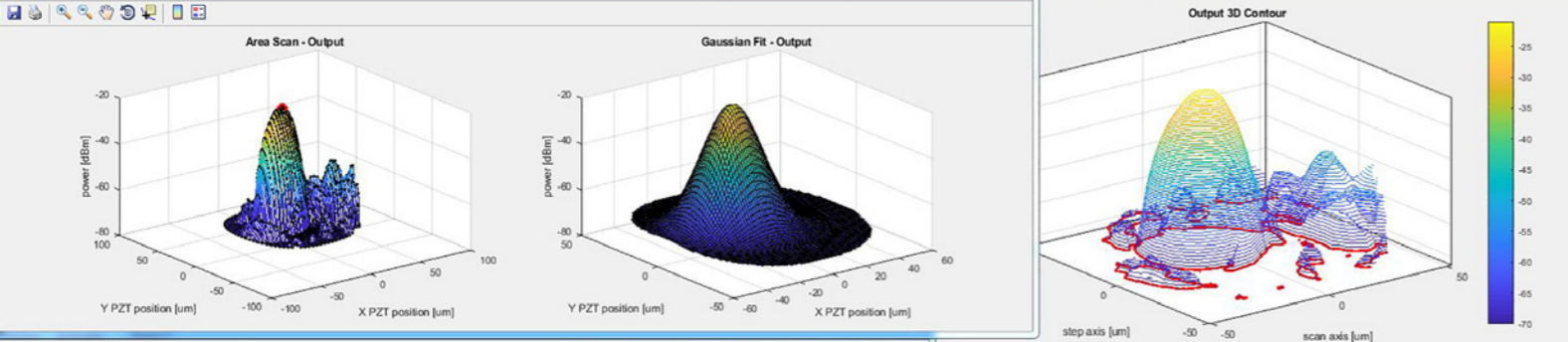

## SiPh-Tools and Photonics Controller Interface Powerful Software Interfaces

### Uniquely Developed Features

Measurement Position Training

Automated Alignment Functions

Optical Alignment Verifications

Wafer Training

Calibration Wafer Verifications

Sub-Die Management



FormFactor's SiPh-Tools is a powerful software package that includes a vast tool set for enabling and facilitating optical probing. By integrating probe station machine vision capability with optical positioning and even test equipment, SiPh-Tools automates manual tasks.

From training measurement positions to performing optical scans during die-to-die stepping, SiPh-Tools

provides the functionality needed to quickly gather data from your devices. One example is the new Search First Light feature that uses outward moves of the hexapod while the nanocube moves in a circular path continuously looking for a measured power signal above a set threshold. SiPh-Tools also has a wide range of tools for capturing, logging and interpreting the data you collect.

### Photonics Controller Interface (PCI)

FormFactor has developed the Photonics Controller Interface (PCI) application which provides a graphical user interface that allows flexibility for the user to manually control the optical positioning system. This feature-rich interface can also be used to setup scan parameter configurations and perform initial optical alignment functions among many other functions. Once aligned, all calibration functions are automated and performed through SiPh-Tools.

and scope positions to probe those location are mapped through a set of coordinate references. Once references have been trained, all optical and electrical positioners in the system and the scope can be automatically moved to arbitrary probing locations that have been specified in wafer coordinates.

### SubDie Mapping

Mapping of sub-die optical and electrical measurement locations for automated stepping to multiple sub-structures within a die can be complicated. FormFactor has developed a function in SiPh-Tools that simplifies this task by enabling the user to map between wafer, positioner, and microscope coordinate systems so that sub-die probing locations can be specified in wafer (e.g., CAD) coordinates. Then the required positioner

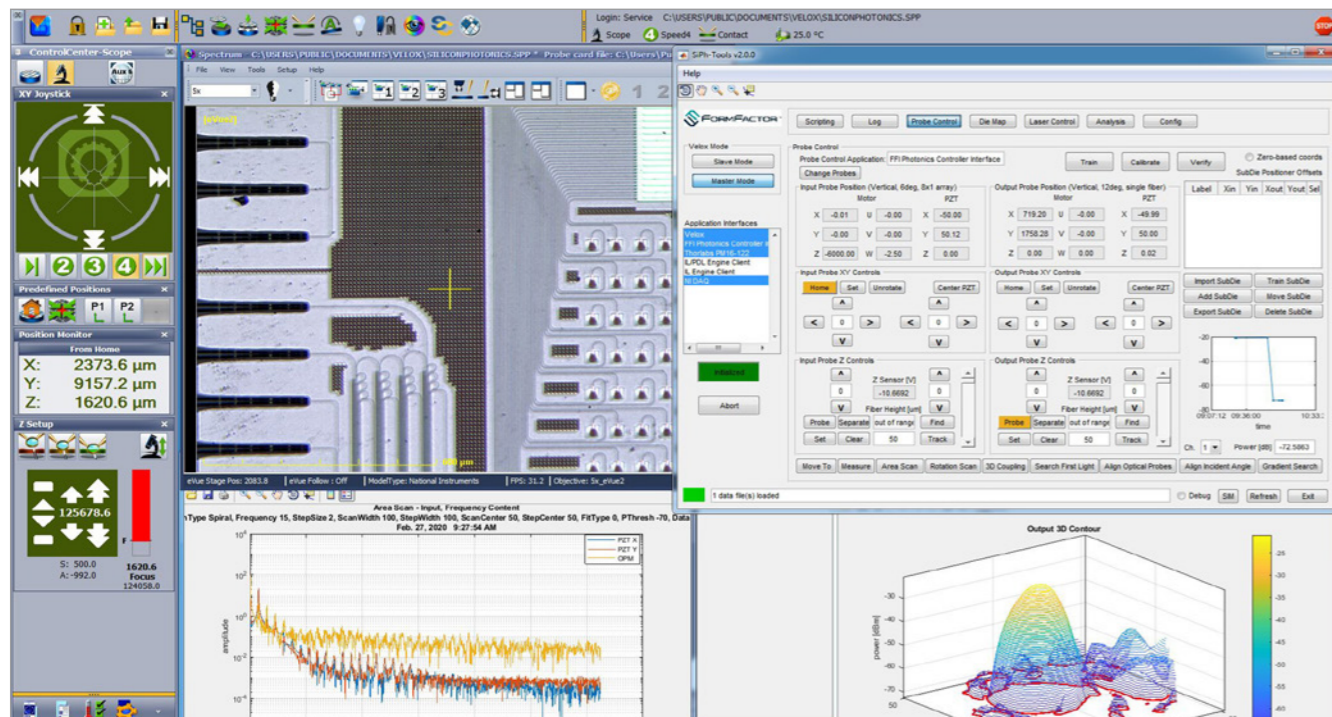
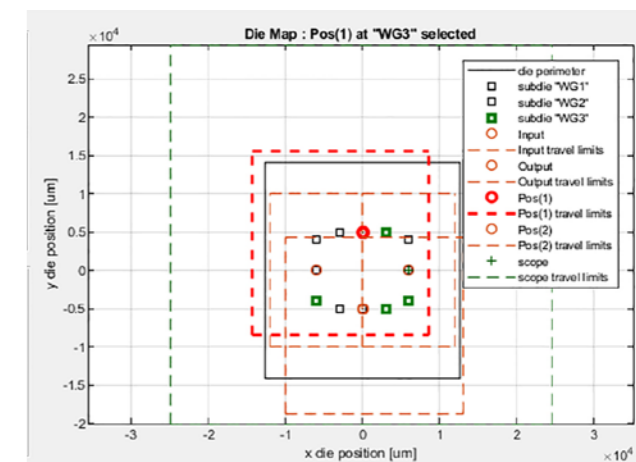

SiPh-Tools provides the communication link between multiple applications, including Velox and PCI.

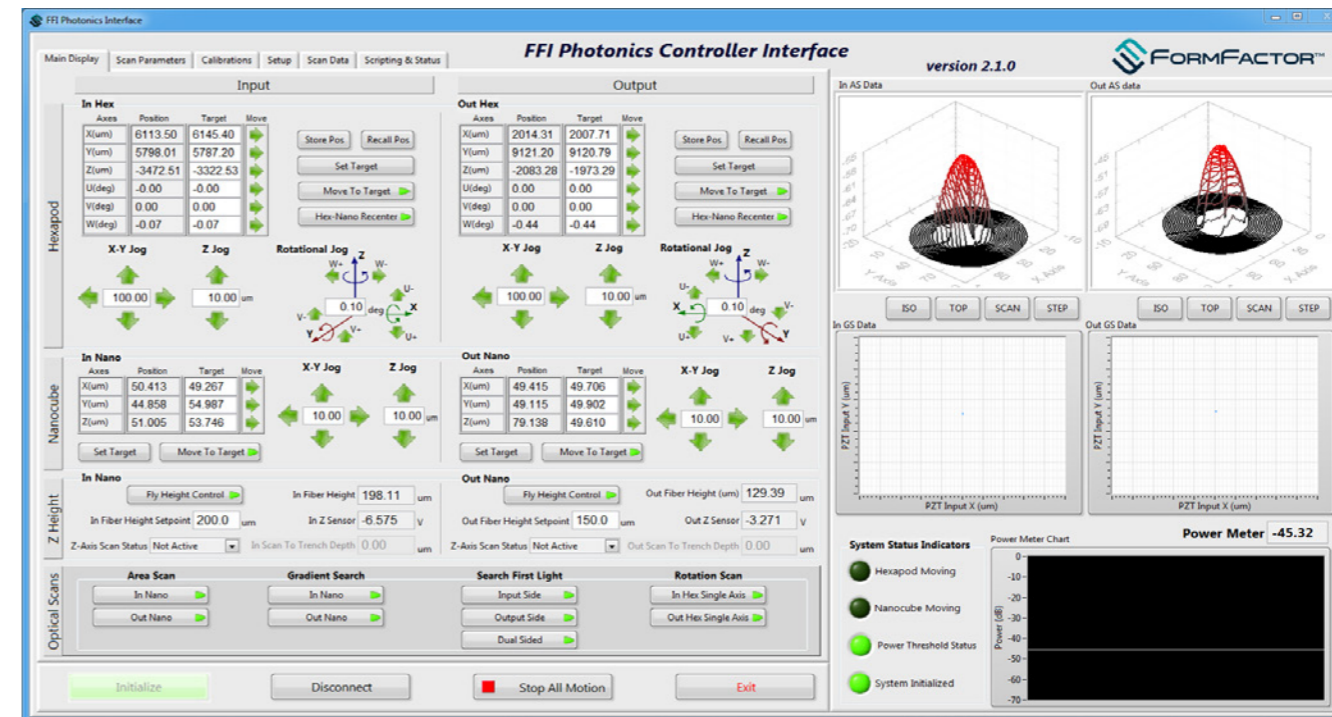

Photonics Controller Interface - controls manual positioning, scan parameter configuration, and initial optical alignment functions.



## Reconfigurable Fiber Arm Perfected Alignment with Precision Z-Displacement

### Reconfigurable Fiber Arm

Flexibility for Engineering and Volume Environments

Supports a Wide Range of Incident Angles

Configurable Between Single Fibers and Fiber Arrays

Z-Displacement Kit Includes Custom Light Weight Close Proximity Integrated Sensors



The rigid design of the fiber arms minimizes resonance, improving scan rates and stability. A replaceable fiber holder allows for switching between different incident angles as well as between single fibers, fiber arrays and edge coupling holders. After changing fiber holders, FormFactor's automated calibration routines will have you back up and running in minutes.

FormFactor's custom setup fixture enables quick changeover between the various fiber holders and includes initial setting of the Z-Displacement sensor.

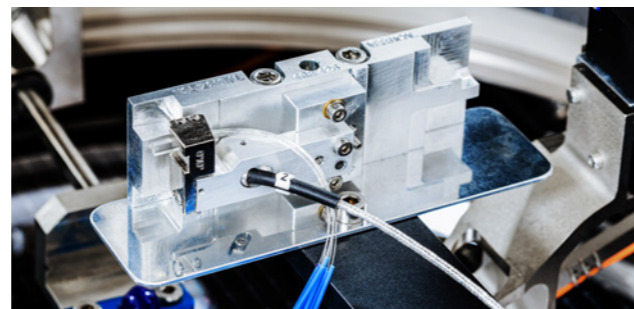

The custom designed nanometer-accuracy integrated Z-Displacement sensor maximizes the testable area of the wafer with its minimal footprint. Its lightweight design and close proximity to the fiber/arrays further guarantees accurate and repeatable data collection.

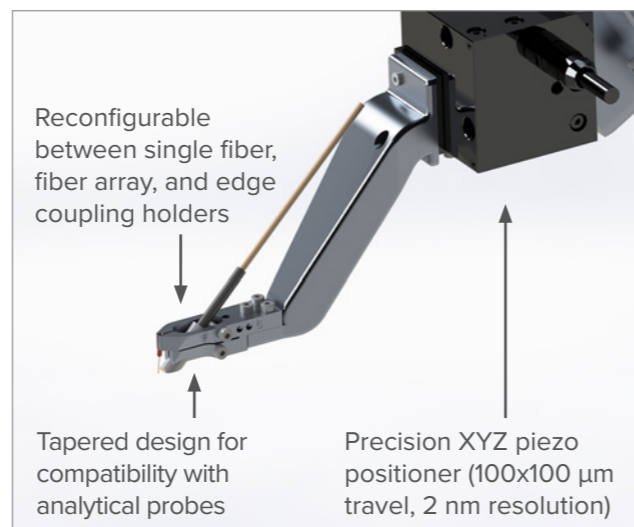
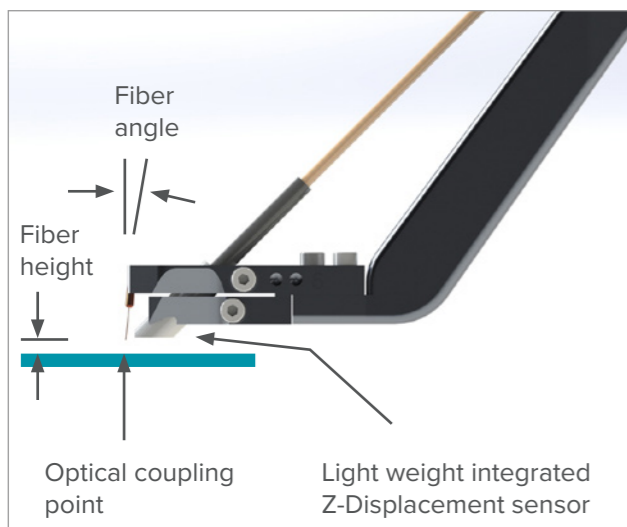

## Fiber/Array Holders Comprehensive Selection for Your Specific Test Requirements

### Features

Wafer-level Edge Coupling Holders

Horizontal Edge Coupling Holders

Vertical Coupling Holders

Single Fibers

Fiber Arrays

Offset Angles

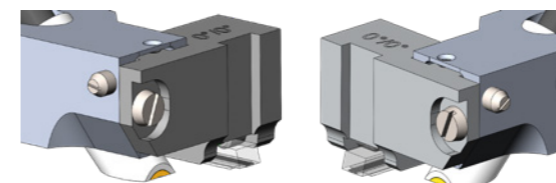

Edge coupling array holder, 90°

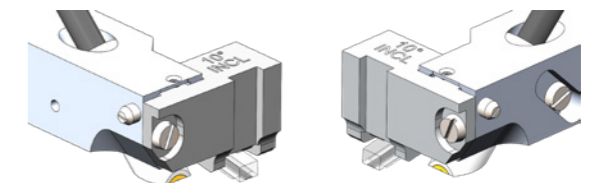

Edge coupling array holder, 70°

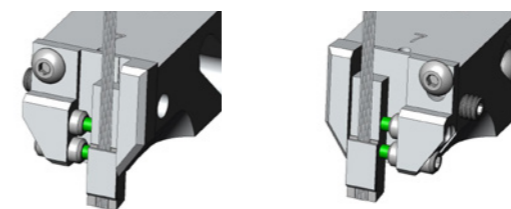

Vertical array holder, 4° to 20°, arrays up to 4.2 mm wide

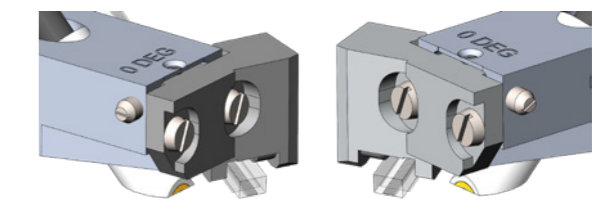

Offset angle fiber holder

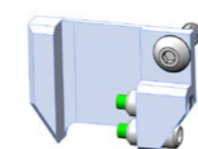

4 – 6 mm arrays

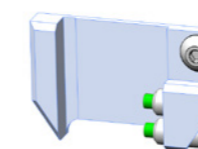

6 – 8 mm arrays

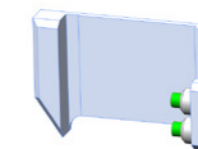

8 – 10 mm arrays

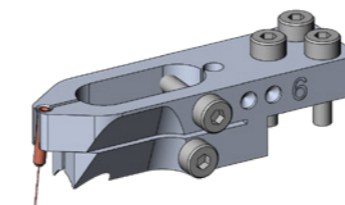

Vertical single fiber holder, 6° to 20°

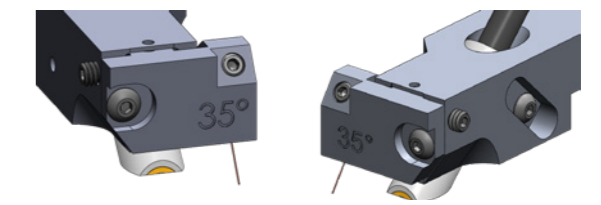

Custom vertical and edge coupling holders, e.g. 35°



## Compatibility

	CM300xi	SUMMIT200
Autonomous Calibration at Multiple Temperatures	✓	✓
Die-Level Edge Coupling	✓	✓
Wafer-Level Edge Coupling	✓	✓
Grating Coupling	✓	✓
OptoVue / OptoVue Pro	✓	✓
Thermal Capability	✓	✓
Semi-auto	✓	✓
Fully-auto	✓	✓

*“GF’s silicon photonics leverages standard silicon manufacturing techniques to improve production efficiency and reduce cost for customers deploying optical interconnect systems. We’re excited to be at the forefront in deploying new test capabilities, including wafer level solutions to ramp this important technology.”*



©Copyright 2021, FormFactor, Inc. All rights reserved. FormFactor and the FormFactor logo are trademarks of FormFactor, Inc. All other trademarks are the property of their respective owners.

This product and this document contain descriptions of technologies and other proprietary information that are the intellectual property of FFI. Any attempt to reverse engineer or copy these technologies is strictly prohibited.

All information is subject to change without notice.

BR-SIPH-0321



[www.formfactor.com](http://www.formfactor.com)



@formfactor



FormFactor Inc.